









| | | |
|---|--|---|
| (1)x1 | (2)x1 | (3)x1 (L)x1 (R) |
|  |  |  |
| (4)x1 | (5)x1 | (6)x1 |
|  |  |  |
| (7)x5 | <p>Please unscrew all screws from cushion before assembly.</p> <p>(A)x2 </p> <p>(B)x4  M8*30" L-BAR SCREW</p> <p>(C)x4  M8*22 MECHANISM SCREW</p> | |
|  | | |

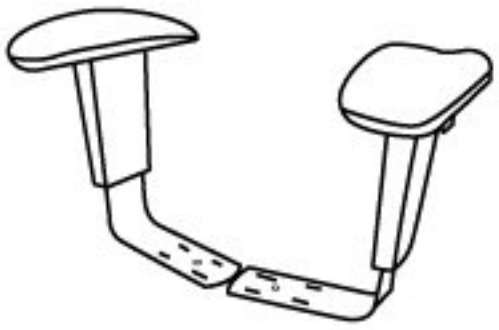
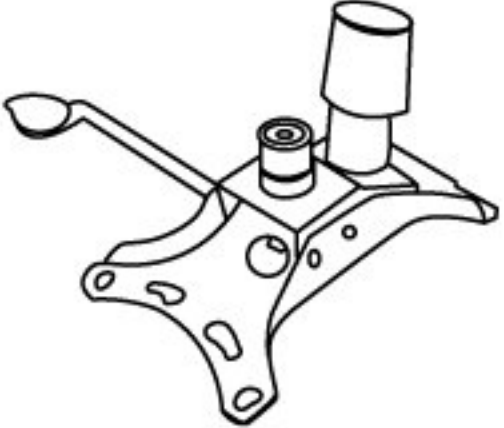
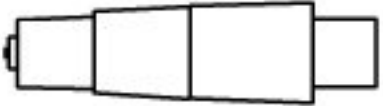

It is important to assemble all parts so that the directional "Arrows" point in the same direction. Make certain that all screws are FULLY tightened before using the chair. Each month, check all screws and tighten any that may have loosened.

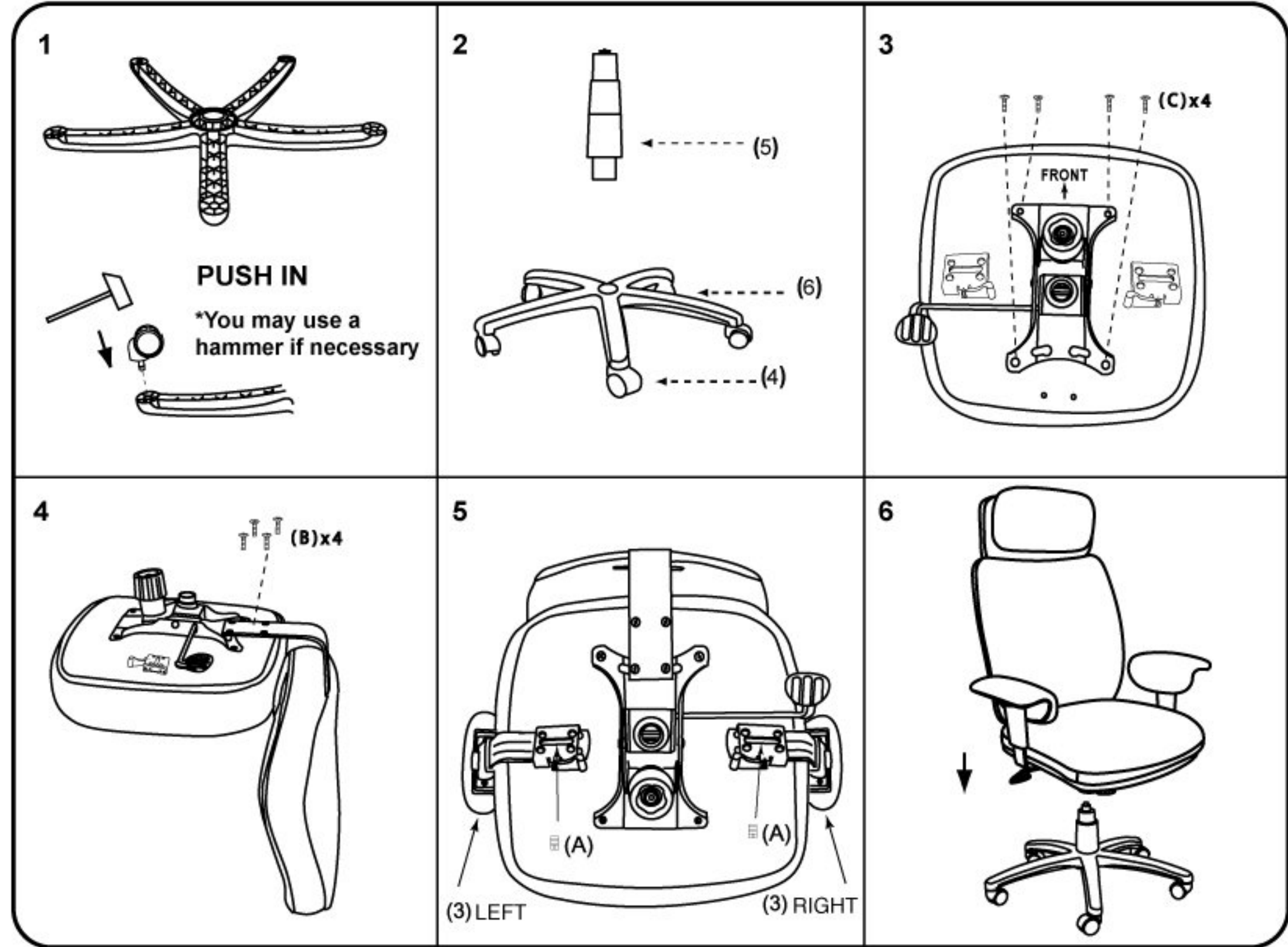