

1

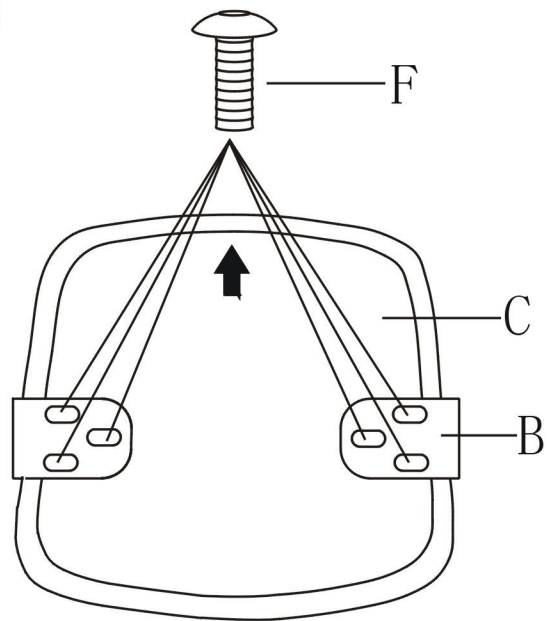

2

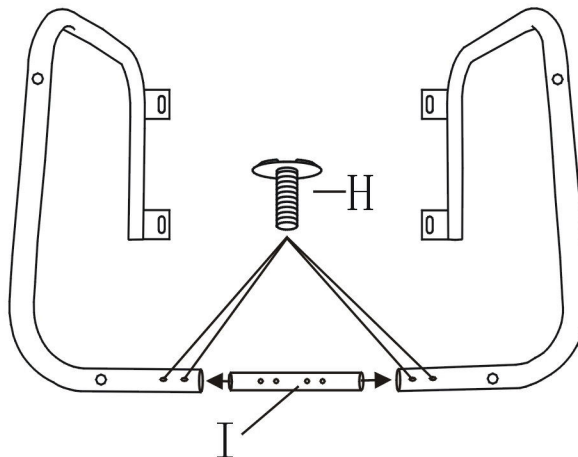

3

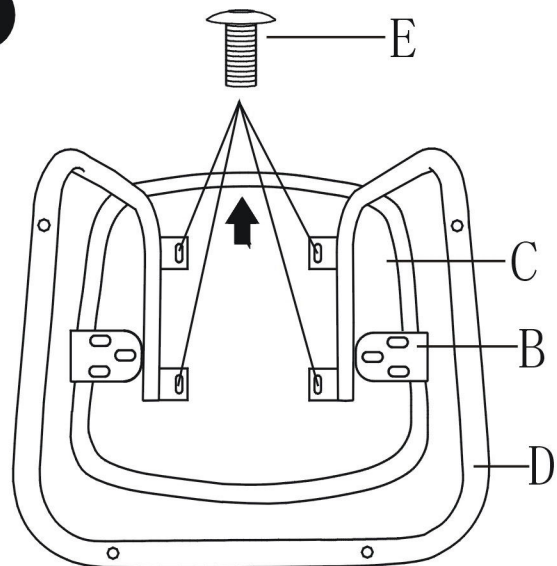

4

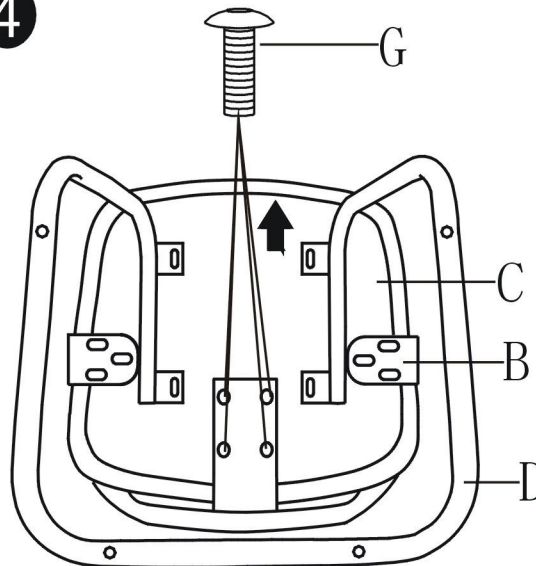

5

F-1102

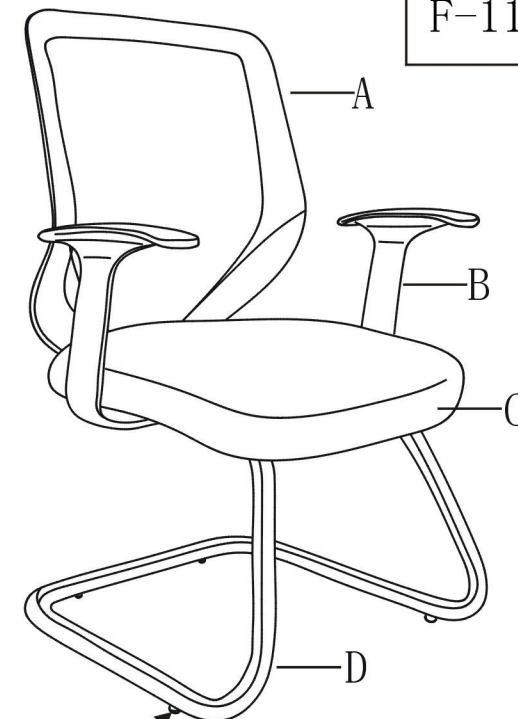

REMARK:
TO ADJUST GRADIENT OF
THE CHAIR BY FOUR SCREWS.

E 
M6*20MM /4PCS

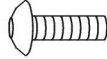
F 
M6*30MM /6PCS

G 
M6*25MM /4PCS

H 
M6*16MM /4PCS

I 

J 
M5 /1PC

K 
M4 /1PC